

Features

- * External Dimensions : 28 x 28 x 1.4
- * Internal Structure : Aluminum Base
- * Luminous Flux : 3,950 lm @ 1,080 mA
- * CRI : Min. 95
- * Thermal Resistance : 0.86 °C/W

Benefits

- * MacAdam 3 step available including ANSI.
- * Multi-chip Power Top View is ideal light sources for common illumination applications, customized solutions, and high performance lights.

Applications

- * Lighting Fixtures
- * Industrial Lighting
- * Architectural Lighting
- * Interior Lighting

COB Multi-chip Power Top View
AM39W-P39-A□□□□



Table of Contents

Part Number Description	-----	p2
Outer Dimension	-----	p3
Specification	-----	p4
Rank	-----	p5
Characteristics Diagrams	-----	p8
Color Rank	-----	p13
Results Of Reliability Test	-----	p24
Packing Standard	-----	p25
Precaution	-----	p27

1. Part Number Description

AM28W – P39 – A□□□□ - (XL)

A	ALLIX
M	Multi-Chip Power
19	PCB Size 13->13*13, 15->15*12, 19->19*19, 28->28*28 38->38*38
w	Color ex) W -> White, P -> Pink, B -> Blue, R : Red G -> Green
P 00	Power Dissipation ex) P5.5 → 5.5W, P11 → 11W, P 13 → 13 watt
A	Color Rendering Index A : High (Ra≥90), B : Medium (Ra=80~89), C : Low (Ra≤79)
□	Color Rank(CCT) ANSI C : 6,500K, D : 5,700K, E : 5,000K, F : 4,500K, G : 4,000K, H : 3,500K, I : 3,000K, J : 2,700K, K : 2,500K, L : 2,200K, M : 2,000K
L 0	Luminous Intensity (Φv lm)
XL	XENOLED™400



2. Outer Dimension

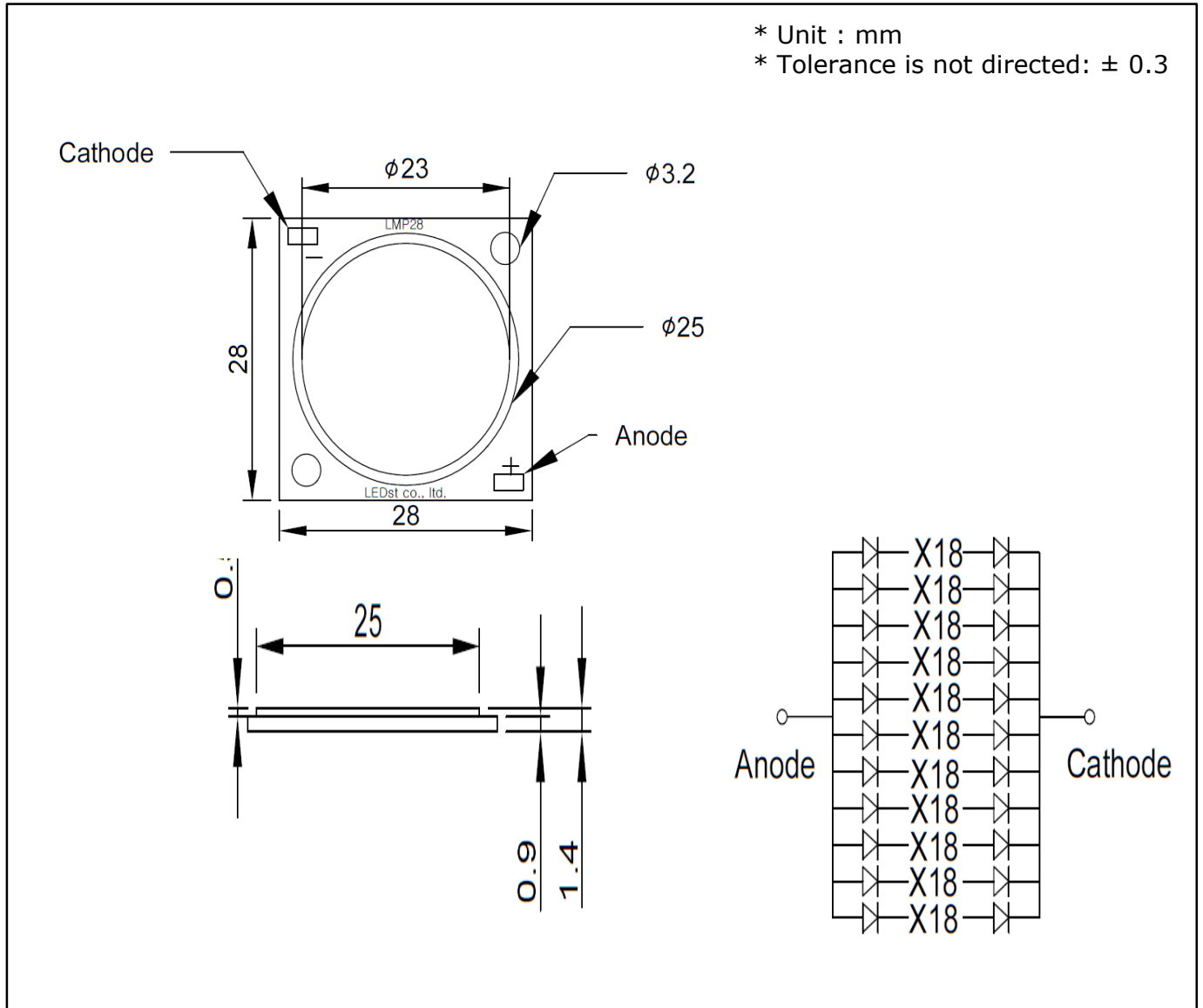

3. Specifications

■ Absolute Maximum Ratings

(T_a=25°C)

Parameter	Symbol	Absolute Maximum Rating	Unit	Remark
Power Dissipation	P _D	84	W	
Forward Current	I _F	2,260	mA	
Pulse Forward Current	I _{FP}	2,350	mA	
Reverse Current	I _R	1	mA	
Operating Temperature	T _{opr}	-30 to +85	°C	
Storage Temperature	T _{stg}	-40 to +100	°C	
Junction Temperature	T _j	125	°C	

Note

* Duty ratio ≤ 1/10, pulse with ≤ 10msec

* D.C Normally: T_j = T_c + R_{j-c} * P_d

(In case of pulse current condition : T_j = T_c + R_{jc} * Pw (1 loss per pulse) * duty)

■ Initial Electrical/Optical Characteristics

(T_a=25°C)

Parameter	Symbol	Condition	Min.	Typ.	Max.	Unit
Forward Voltage	V _F	I _F = 1,080mA	-	36	-	V
Luminous Flux	Φ _v	I _F = 1,080mA	-	3,950	-	lm
Optical Efficiency	η _{elc}	I _F = 1,080mA	-	100	-	lm/W
Color Temperature (=5,000K)	CCT	I _F = 1,080mA	-	5,000	-	K
Color Rendering Index(CRI)	R _a	I _F = 1,080mA	-	96	-	
Thermal Resistance	R _{j-c}	★	-	0.82	-	°C/W

Note

★ Junction-Case

* Forward Voltage Measurement allowance ± 3%

* Luminous Intensity or Luminous Flux Measurement allowance is ± 10%



4. Rank

CCT Range (K)	CRI		Base Order Codes Min. Luminous Flux @1,080mA		ANSI Rank	Mac-Adam 3step Rank	Device
	Min	Typ	Group	Flux(lm) @25°C	Chromaticity Region	Chromaticity Region	
6,500K	95	96	L36	3400-3600	C	C1	AM28W-P39-AC1L36
			L37	3600-3800			AM28W-P39-AC1L37
			L38	3800-4000			AM28W-P39-AC1L38
			L39	4000-4200			AM28W-P39-AC1L39
			L40	4200-4400			AM28W-P39-AC1L40
5,700K	95	96	L36	3400-3600	D	D1	AM28W-P39-AD1L36
			L37	3600-3800			AM28W-P39-AD1L37
			L38	3800-4000			AM28W-P39-ADL38
			L39	4000-4200			AM28W-P39-AD1L39
			L40	4200-4400			AM28W-P39-AD1L40
5,000K	95	96	L36	3400-3600	E	E1	AM28W-P39-AE1L36
			L37	3600-3800			AM28W-P39-AE1L37
			L38	3800-4000			AM28W-P39-AE1L38
			L39	4000-4200			AM28W-P39-AE1L39
			L40	4200-4400			AM28W-P39-AE1L40
4,500K	95	96	L36	3400-3600	F	F1	AM28W-P39-AF1L36
			L37	3600-3800			AM28W-P39-AF1L37
			L38	3800-4000			AM28W-P39-AF1L38
			L39	4000-4200			AM28W-P39-AF1L39
			L40	4200-4400			AM28W-P39-AF1L40



Production Specification

AM28W-P39 Series

CCT Range (K)	CRI		Base Order Codes Min. Luminous Flux @1,080mA		ANSI Rank	Mac-Adam 3step Rank	Device
	Min	Typ	Group	Flux(lm) @25°C	Chromaticity Region	Chromaticity Region	
4,000K	95	97	L36	3400-3600	G	G1	AM28W-P39-AG1L36
			L37	3600-3800			AM28W-P39-AG1L37
			L38	3800-4000			AM28W-P39-AG1L38
			L39	4000-4200			AM28W-P39-AG1L39
			L40	4200-4400			AM28W-P39-AG1L40
3,500K	95	97	L33	2800-3000	H	H1	AM28W-P39-AH1L33
			L34	3000-3200			AM28W-P39-AH1L34
			L35	3200-3400			AM28W-P39-AH1L35
			L36	3400-3600			AM28W-P39-AH1L36
			L37	3600-3800			AM28W-P39-AH1L37
3,000K	95	97	L33	2800-3000	I	I1	AM28W-P39-AI1L33
			L34	3000-3200			AM28W-P39-AI1L34
			L35	3200-3400			AM28W-P39-AI1L35
			L36	3400-3600			AM28W-P39-AI1L36
			L37	3600-3800			AM28W-P39-AI1L37
2,700K	95	97	L33	2800-3000	J	J1	AM28W-P39-AJ1L33
			L34	3000-3200			AM28W-P39-AJ1L34
			L35	3200-3400			AM28W-P39-AJ1L35
			L36	3400-3600			AM28W-P39-AJ1L36
			L37	3600-3800			AM28W-P39-AJ1L37



Production Specification

AM28W-P39 Series

CCT Range (K)	CRI		Base Order Codes Min. Luminous Flux @1,080mA		ANSI Rank	Mac-Adam 3step Rank	Device
	Min	Typ	Group	Flux(lm) @25°C	Chromaticity Region	Chromaticity Region	
2,500K	95	97	L33	2800-3000	K	K1	AM28W-P39-AK1L33
			L34	3000-3200			AM28W-P39-AK1L34
			L35	3200-3400			AM28W-P39-AK1L35
			L36	3400-3600			AM28W-P39-AK1L36
			L37	3600-3800			AM28W-P39-AK1L37
2,200K	95	97	L33	2800-3000	L	L1	AM28W-P39-AL1L33
			L34	3000-3200			AM28W-P39-AL1L34
			L35	3200-3400			AM28W-P39-AL1L35
			L36	3400-3600			AM28W-P39-AL1L36
			L37	3600-3800			AM28W-P39-AL1L37
2,000K	95	97	L33	2800-3000	M	M1	AM28W-P39-AM1L33
			L34	3000-3200			AM28W-P39-AM1L34
			L35	3200-3400			AM28W-P39-AM1L35
			L36	3400-3600			AM28W-P39-AM1L36
			L37	3600-3800			AM28W-P39-AM1L37



5. Characteristics Diagrams

($T_a=25^{\circ}\text{C}$)

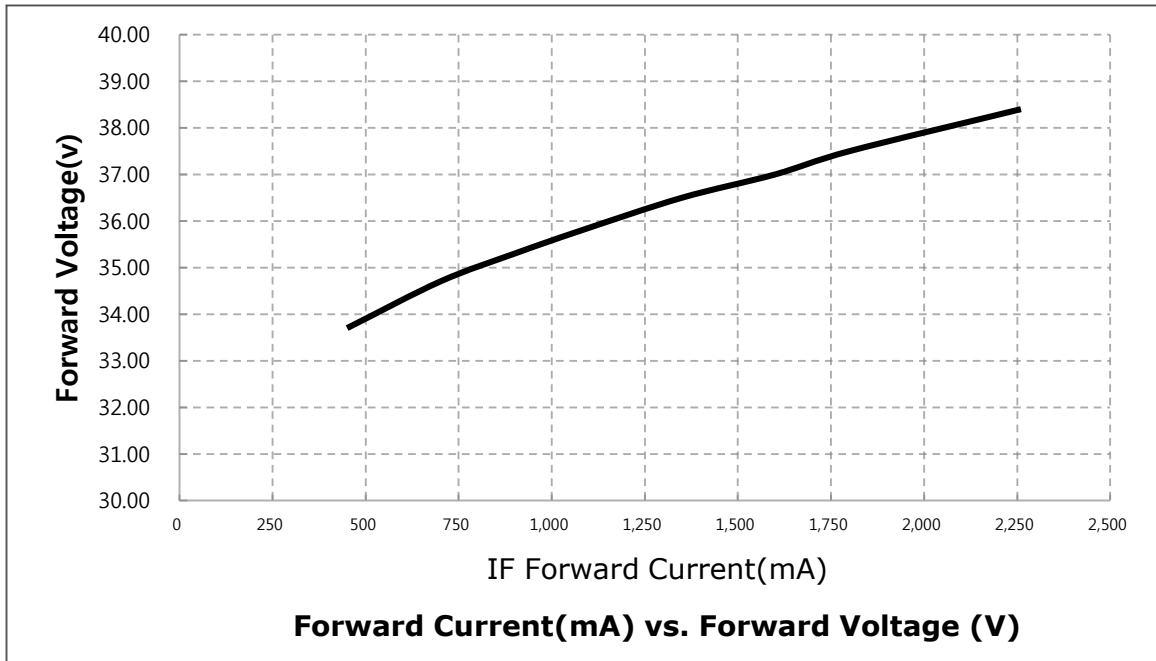

($T_a=25^{\circ}\text{C}$)

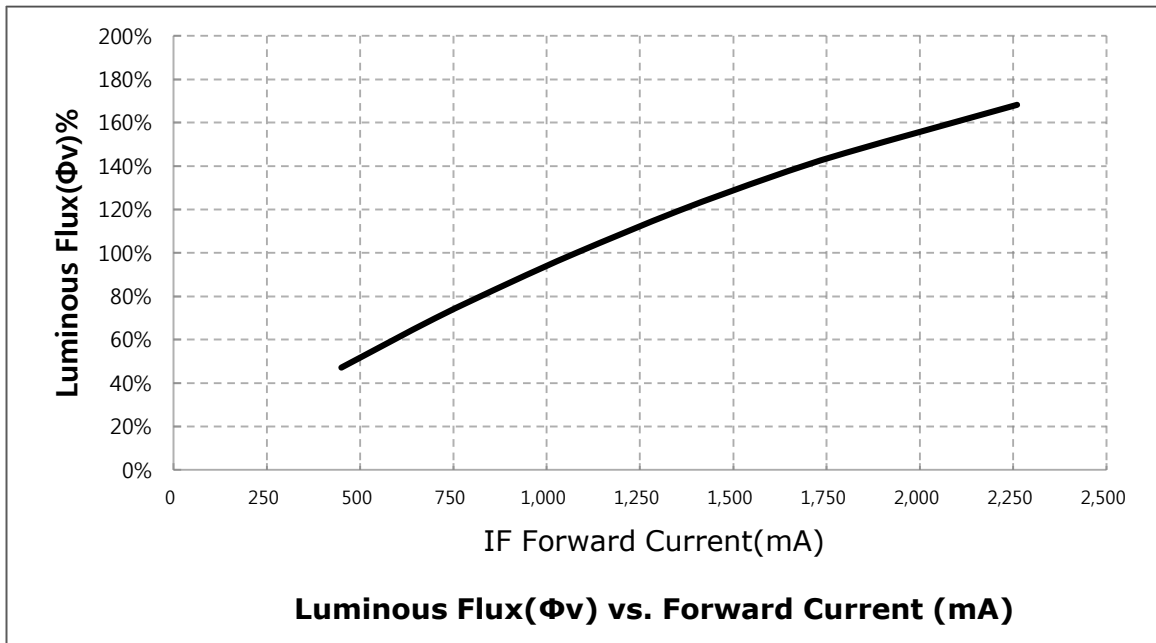

($T_a=25^\circ\text{C}$)

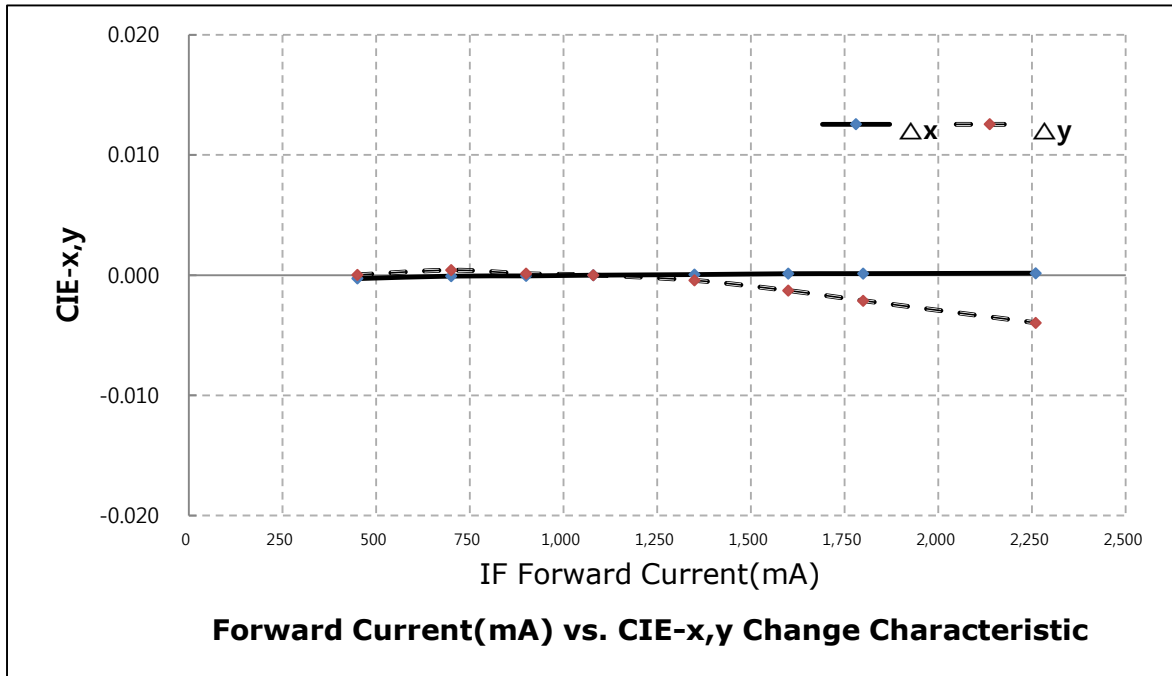

($I_F=1,080\text{mA}$)

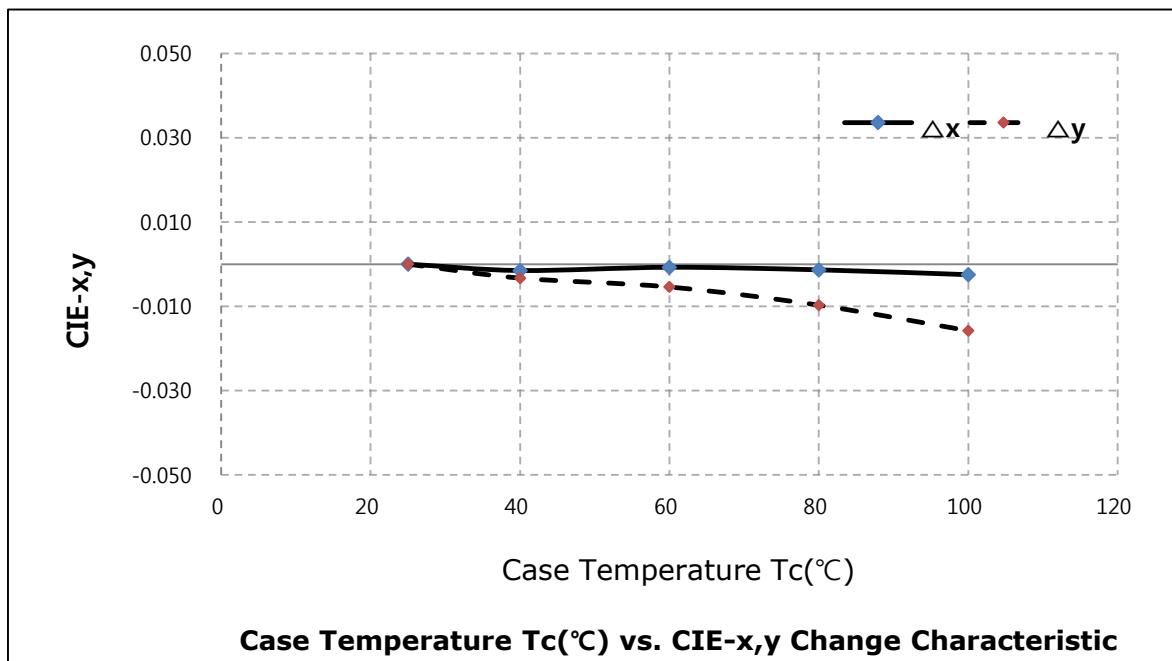

($I_F=1,080\text{mA}$)

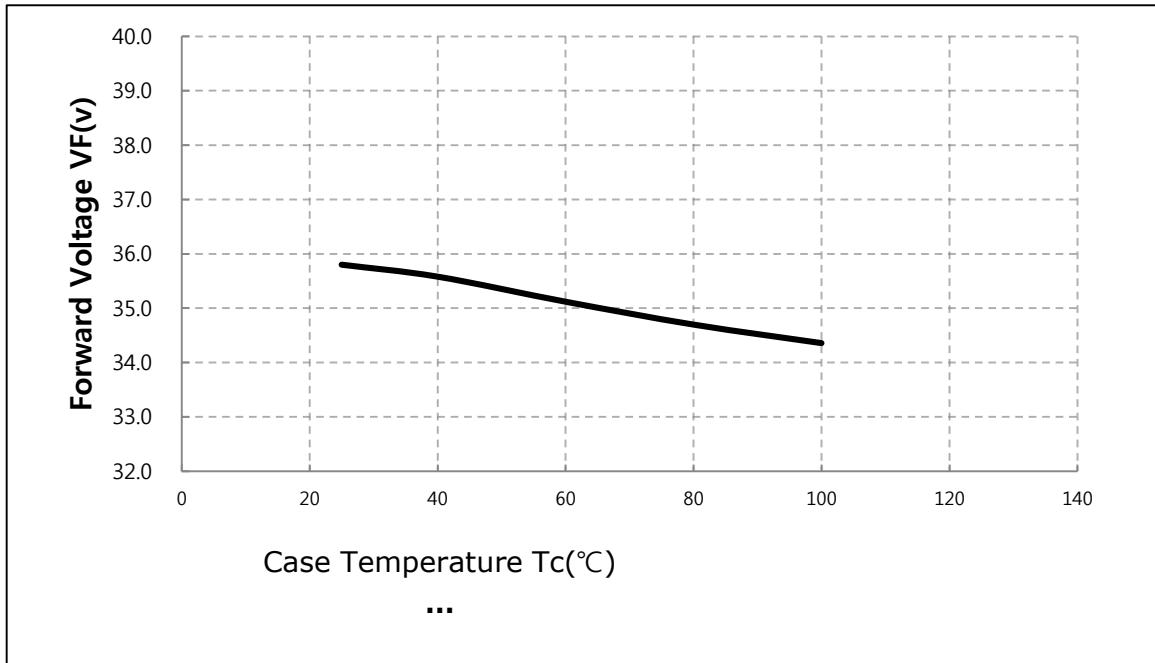

($I_F=1,080\text{mA}$)

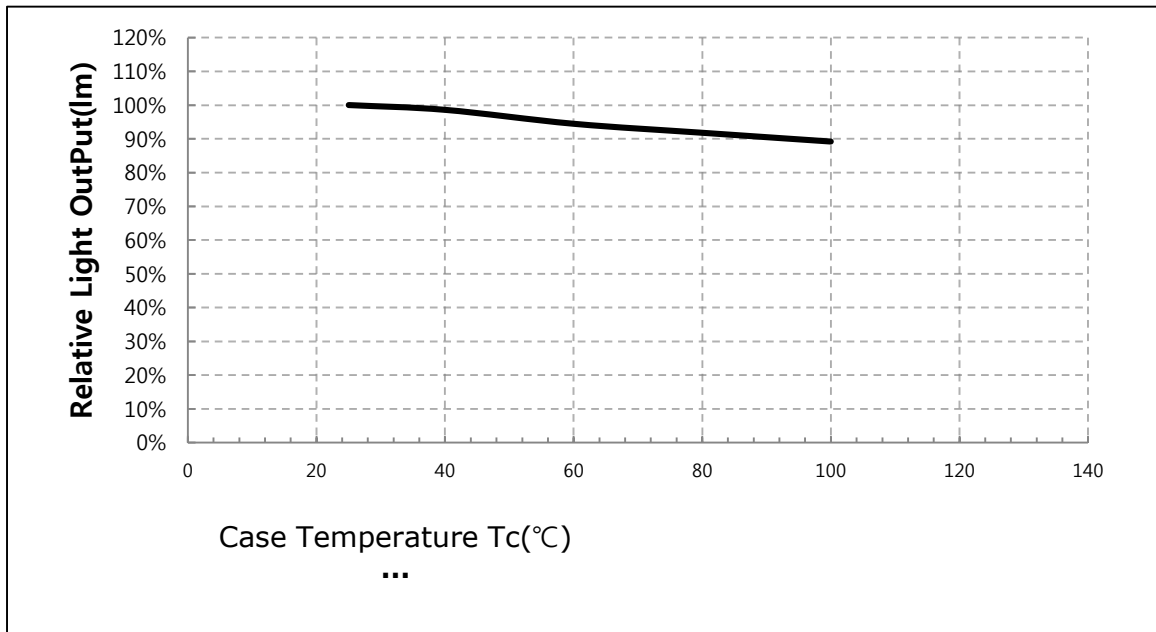

($I_F=1,080\text{mA}$)

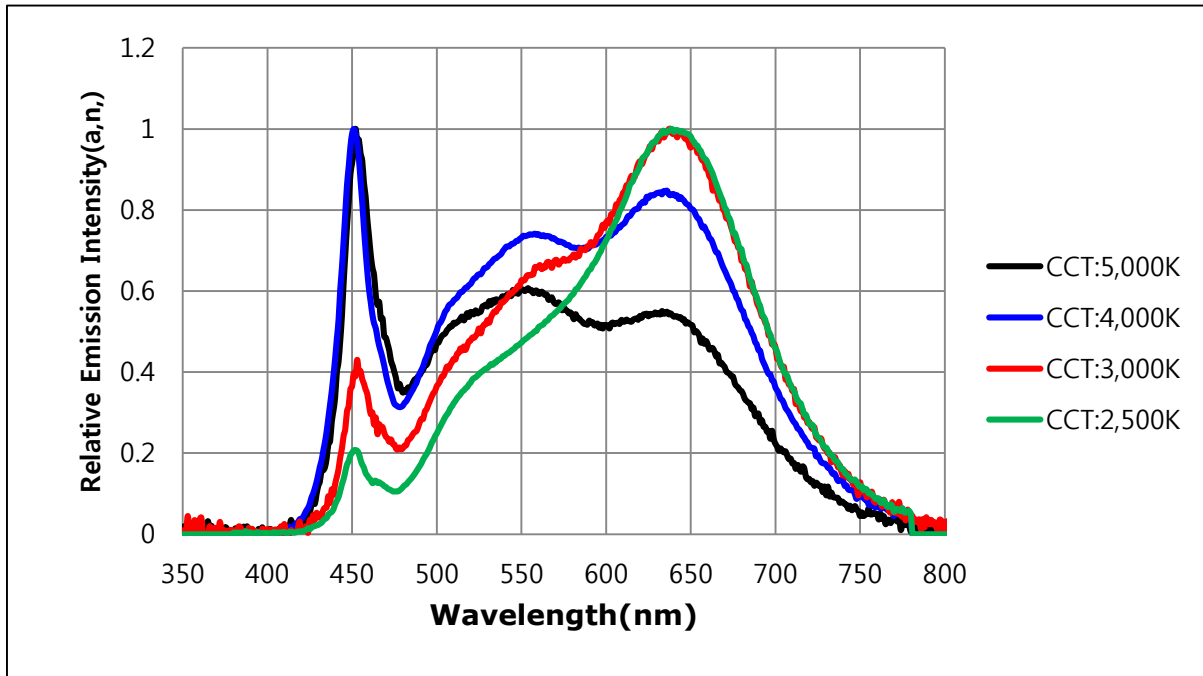

($I_F=1,080\text{mA}$)

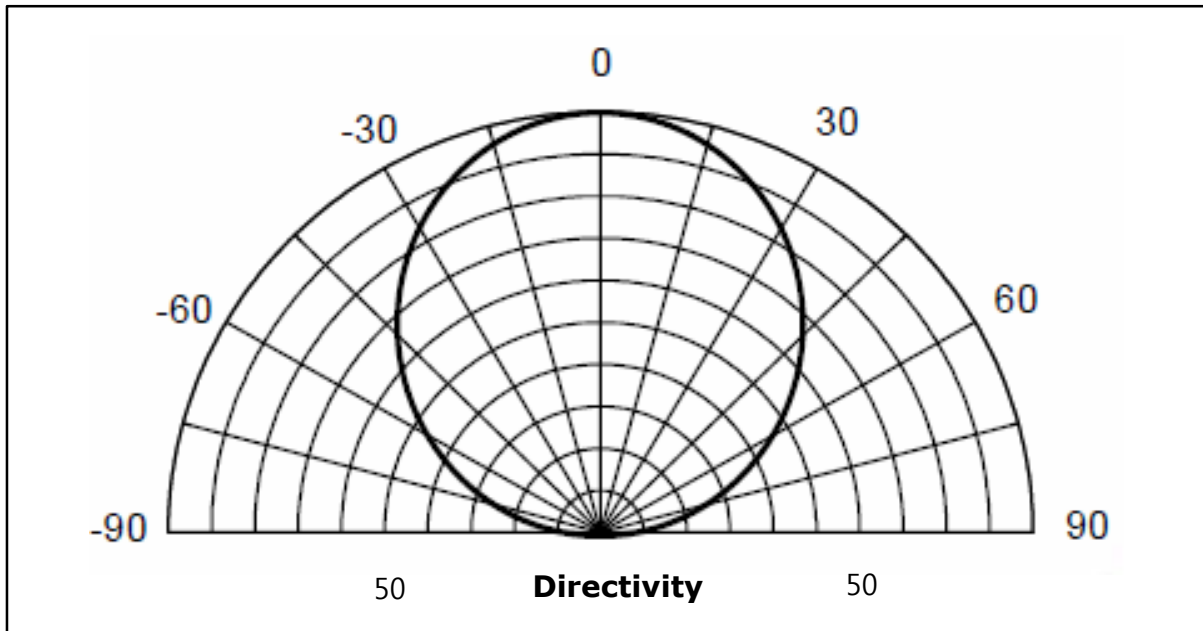

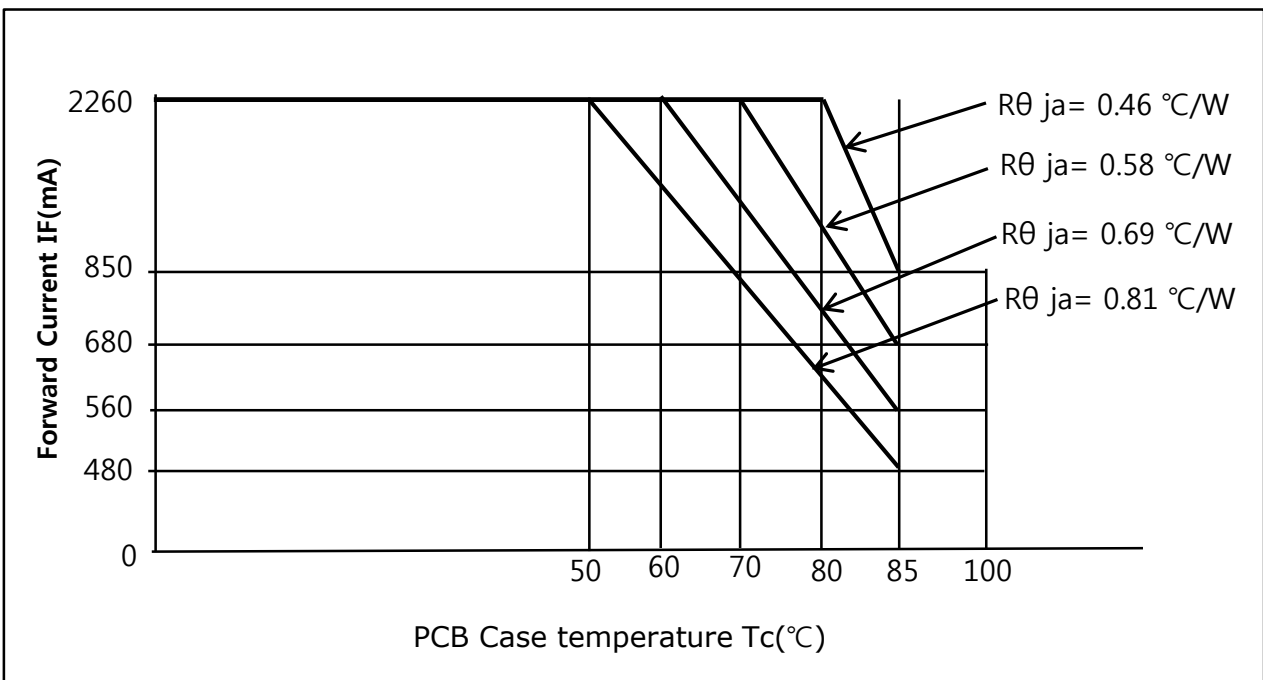
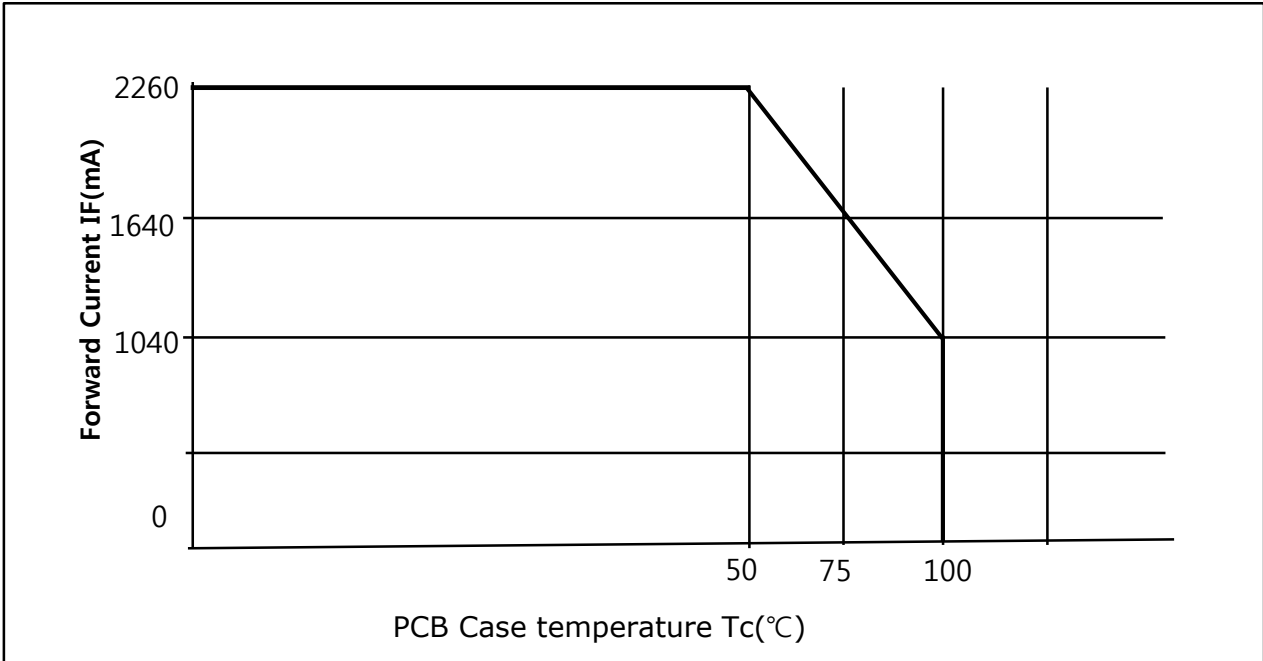

6. Color Rank

CCT(K)	CIE-x,y Avg		CCT : 6,500K		CCT : 6,500K	
	CIE-x	CIE-y	ANSI Rank		Mac-Adam 3-step Rank	
6,500K	0.3131	0.3290	CIE-x	CIE-y	CIE-x	CIE-y
	Ellipse Parameter		0.3028	0.3304	0.3098	0.3209
	Major Axis Distance a	0.00223	0.3068	0.3113	0.3083	0.3292
	Major Axis Distance b	0.00095	0.3221	0.3261	0.3164	0.3372
	Angle θ°	58.57	0.3205	0.3481	0.3172	0.3282

Note

* MacAdam 3-step range from the center of chromaticity

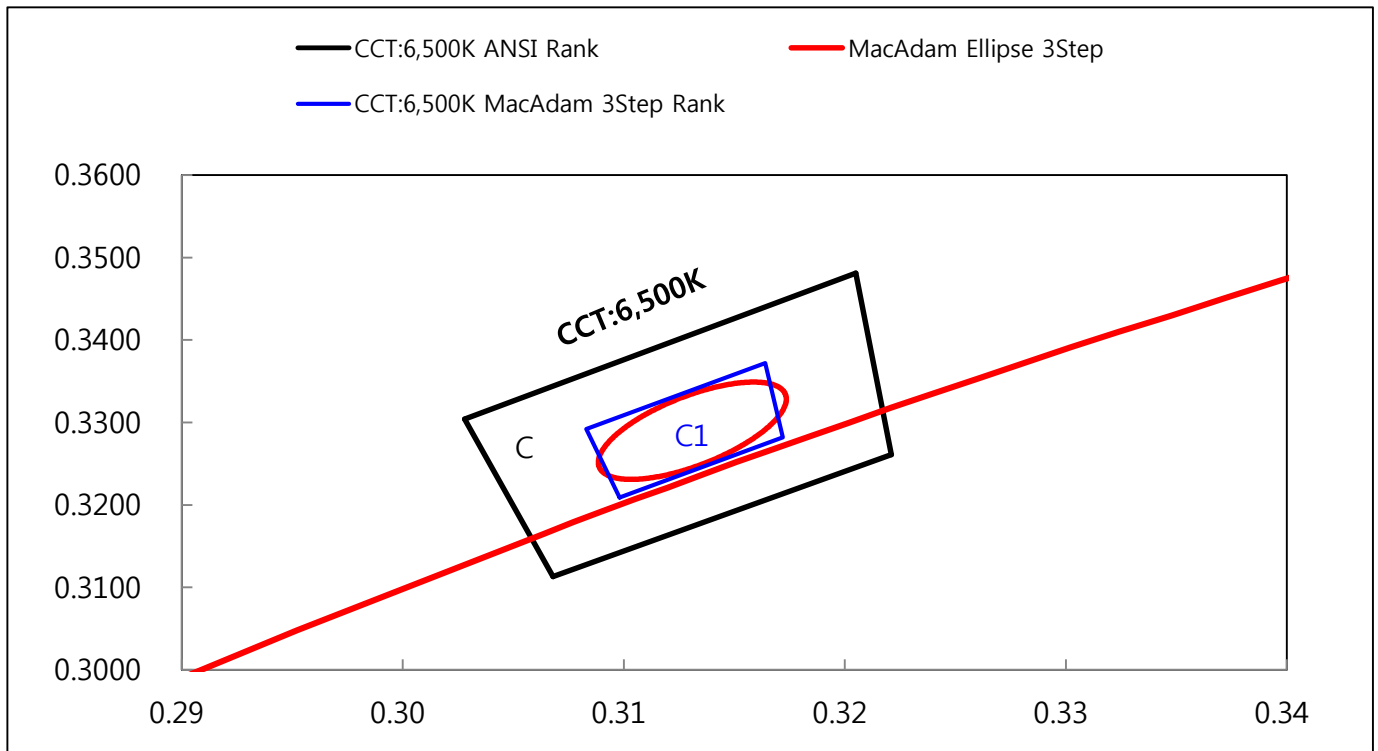

Note

* Chromaticity coordinates measurement allowance is ± 0.01



CCT(K)	CIE-x,y Avg		CCT : 5,700K		CCT : 5,700K	
	CIE-x	CIE-y	ANSI Rank		Mac-Adam 3-step Rank	
5,700K	0.3293	0.3423	CIE-x	CIE-y	CIE-x	CIE-y
	Ellipse Parameter		0.3207	0.3462	0.3256	0.3432
	Major Axis Distance a	0.00223	0.3222	0.3243	0.3258	0.3346
	Major Axis Distance b	0.00095	0.3366	0.3369	0.3329	0.3416
	Angle θ°	58.57	0.3376	0.3616	0.3329	0.3505

Note

* MacAdam 3-step range from the center of chromaticity

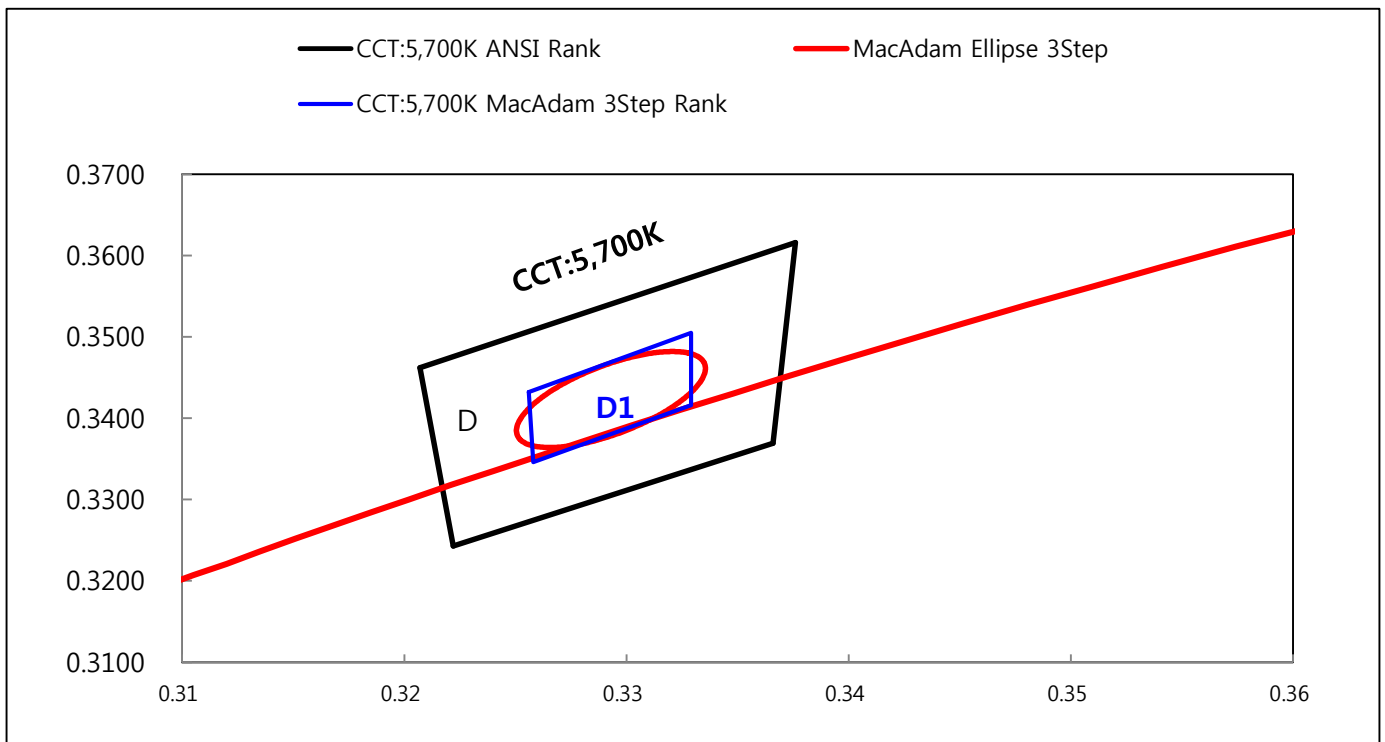

Note

* Chromaticity coordinates measurement allowance is ± 0.01



CCT(K)	CIE-x,y Avg		CCT : 5,000K		CCT : 5,000K	
	CIE-x	CIE-y	ANSI Rank		Mac-Adam 3-step Rank	
5,000K	0.3452	0.3558	CIE-x	CIE-y	CIE-x	CIE-y
	Ellipse Parameter		0.3376	0.3616	0.3413	0.3574
	Major Axis Distance a	0.00274	0.3366	0.3369	0.3407	0.3459
	Major Axis Distance b	0.00118	0.3515	0.3487	0.3489	0.3531
	Angle θ°	59.62	0.3551	0.3760	0.3499	0.3649

Note
 * MacAdam 3-step range from the center of chromaticity

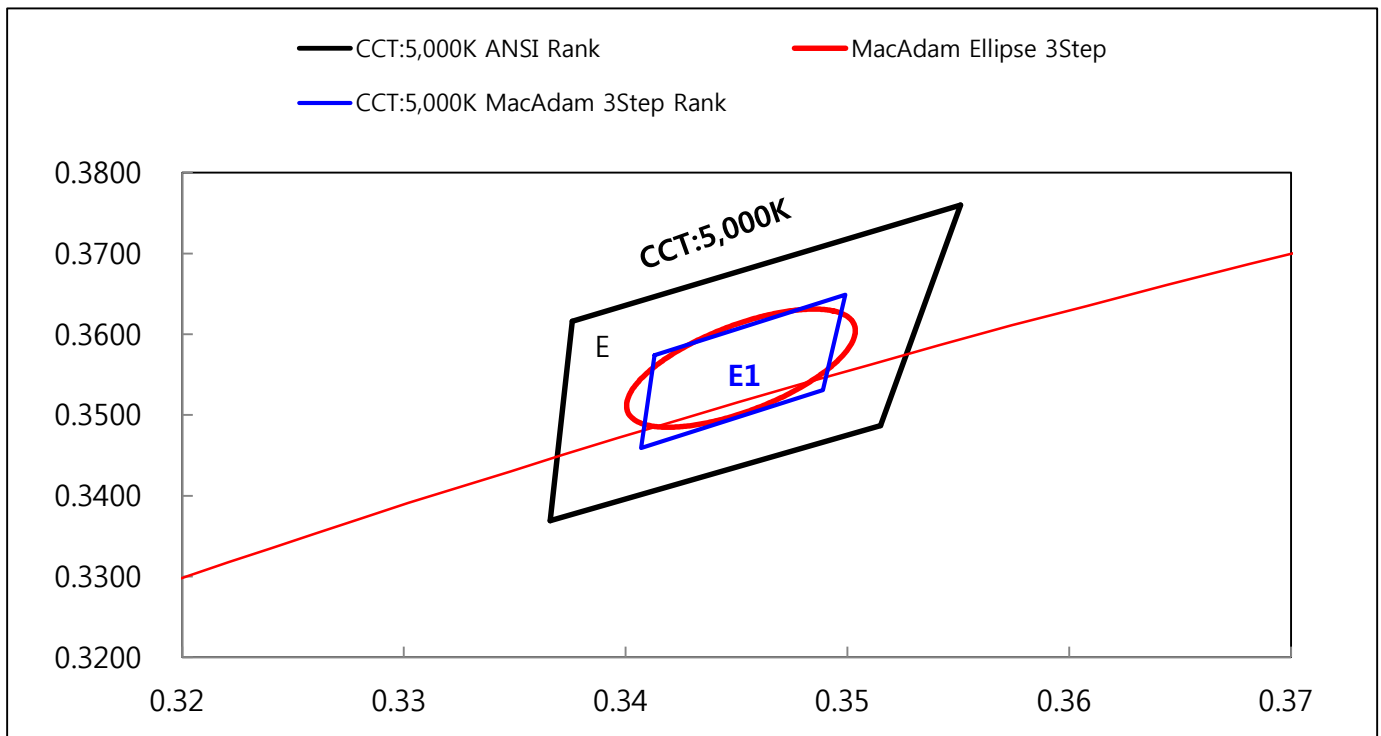

Note
 * Chromaticity coordinates measurement allowance is ± 0.01



CCT(K)	CIE-x,y Avg		CCT : 4,500K		CCT : 4,500K	
	CIE-x	CIE-y	ANSI Rank		Mac-Adam 3-step Rank	
4,500K	0.3617	0.3668	CIE-x	CIE-y	CIE-x	CIE-y
	Ellipse Parameter		0.3548	0.3736	0.3554	0.3558
	Major Axis Distance a	0.00313	0.3512	0.3465	0.3571	0.3690
	Major Axis Distance b	0.00134	0.3670	0.3578	0.3676	0.3770
	Angle θ°	53.72	0.3736	0.3874	0.3653	0.3628

Note

* MacAdam 3-step range from the center of chromaticity

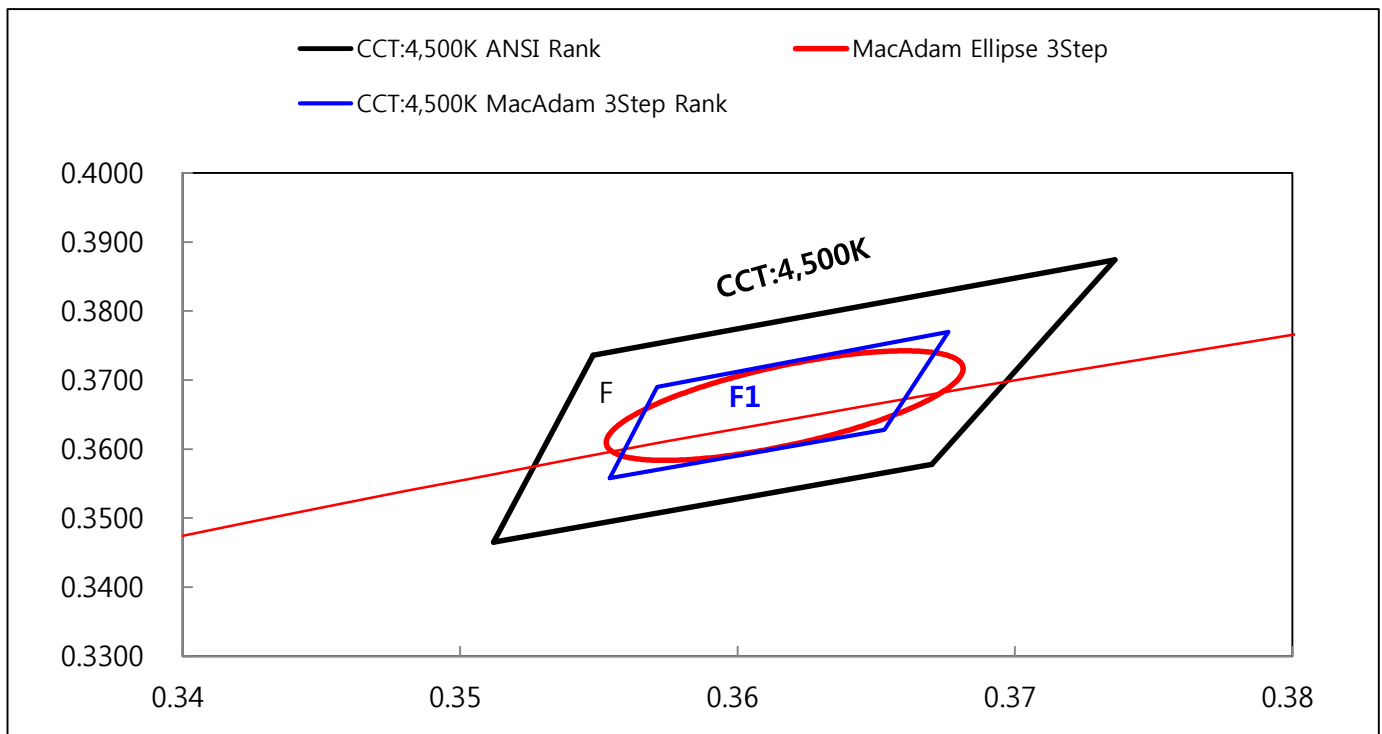

Note

* Chromaticity coordinates measurement allowance is ± 0.01

CCT(K)	CIE-x,y Avg		CCT : 4,000K		CCT : 4,000K	
	CIE-x	CIE-y	ANSI Rank		Mac-Adam 3-step Rank	
4,000K	0.3828	0.3803	CIE-x	CIE-y	CIE-x	CIE-y
	Ellipse Parameter		0.3736	0.3874	0.3756	0.3690
	Major Axis Distance a	0.00313	0.3670	0.3578	0.3789	0.3830
	Major Axis Distance b	0.00134	0.3898	0.3716	0.3901	0.3910
	Angle θ°	53.72	0.4006	0.4044	0.3861	0.3770

Note

* MacAdam 3-step range from the center of chromaticity

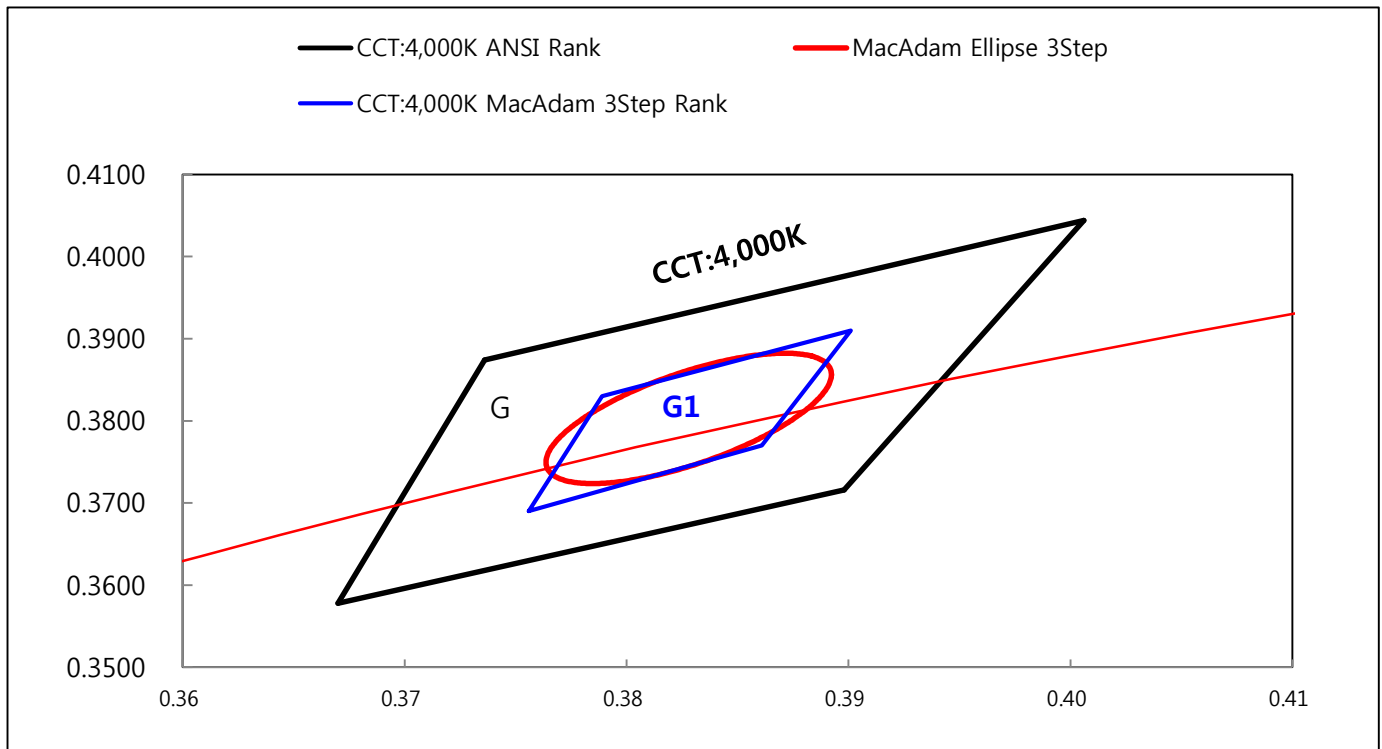

Note

* Chromaticity coordinates measurement allowance is ± 0.01

CCT(K)	CIE-x,y Avg		CCT : 3,500K		CCT : 3,500K	
	CIE-x	CIE-y	ANSI Rank		Mac-Adam 3-step Rank	
3,500K	0.4083	0.3921	CIE-x	CIE-y	CIE-x	CIE-y
	Ellipse Parameter		0.3996	0.4015	0.4043	0.3955
	Major Axis Distance a	0.00309	0.3889	0.3690	0.4018	0.3820
	Major Axis Distance b	0.00138	0.4147	0.3814	0.4120	0.3885
	Angle θ°	54	0.4299	0.4165	0.4145	0.4020

Note

* MacAdam 3-step range from the center of chromaticity

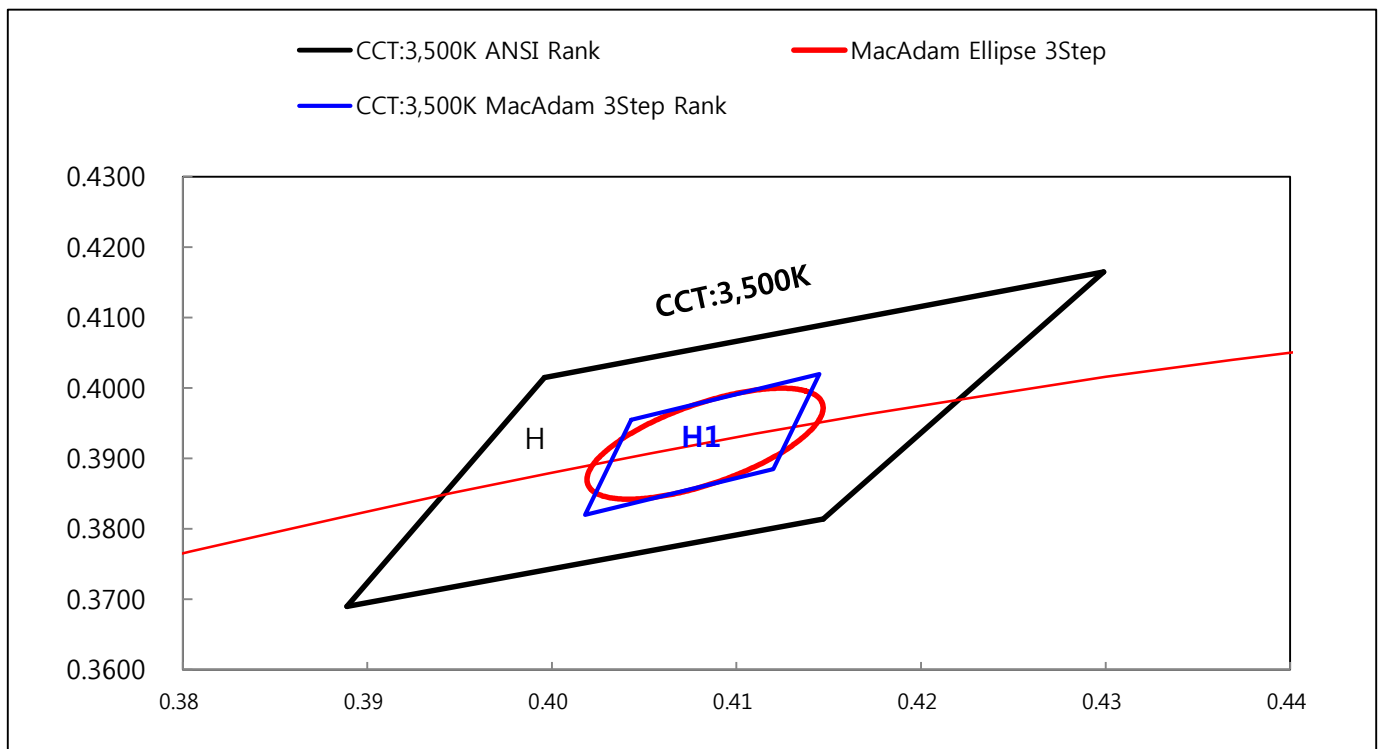

Note

* Chromaticity coordinates measurement allowance is ± 0.01

CCT(K)	CIE-x,y Avg		CCT : 3,000K		CCT : 3,000K	
	CIE-x	CIE-y	ANSI Rank		Mac-Adam 3-step Rank	
3,000K	0.4345	0.4033	CIE-x	CIE-y	CIE-x	CIE-y
	Ellipse Parameter		0.4299	0.4165	0.4310	0.4065
	Major Axis Distance a	0.00278	0.4147	0.3814	0.4285	0.3960
	Major Axis Distance b	0.00136	0.4373	0.3893	0.4380	0.4005
	Angle θ°	53.22	0.4562	0.4260	0.4405	0.4110

Note

* MacAdam 3-step range from the center of chromaticity

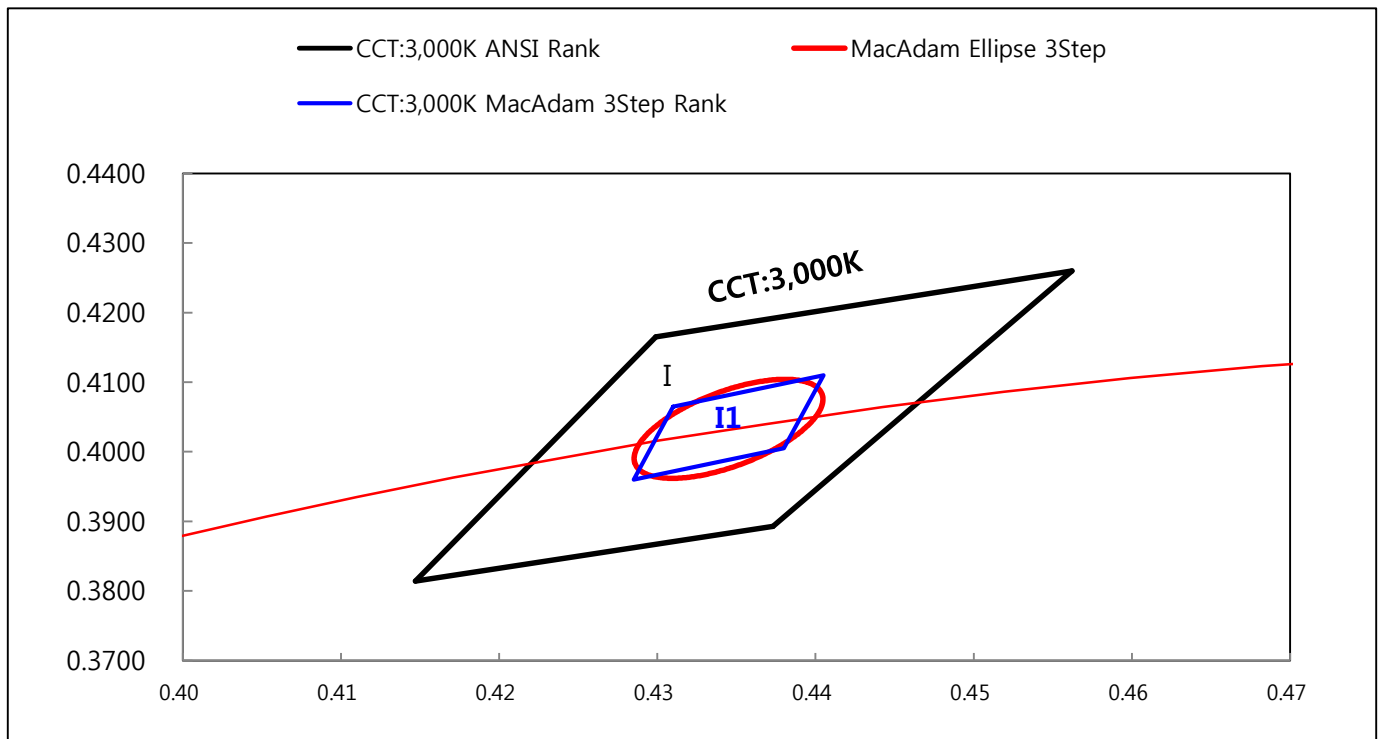

Note

* Chromaticity coordinates measurement allowance is ± 0.01

CCT(K)	CIE-x,y Avg		CCT : 2,700K		CCT : 2,700K	
	CIE-x	CIE-y	ANSI Rank		Mac-Adam 3-step Rank	
2,700K	0.4585	0.4104	CIE-x	CIE-y	CIE-x	CIE-y
	Ellipse Parameter		0.4562	0.4260	0.4551	0.4130
	Major Axis Distance a	0.0027	0.4373	0.3893	0.4525	0.4025
	Major Axis Distance b	0.0014	0.4593	0.3944	0.4626	0.4085
	Angle θ°	53.7	0.4813	0.4319	0.4645	0.4185

Note

* MacAdam 3-step range from the center of chromaticity

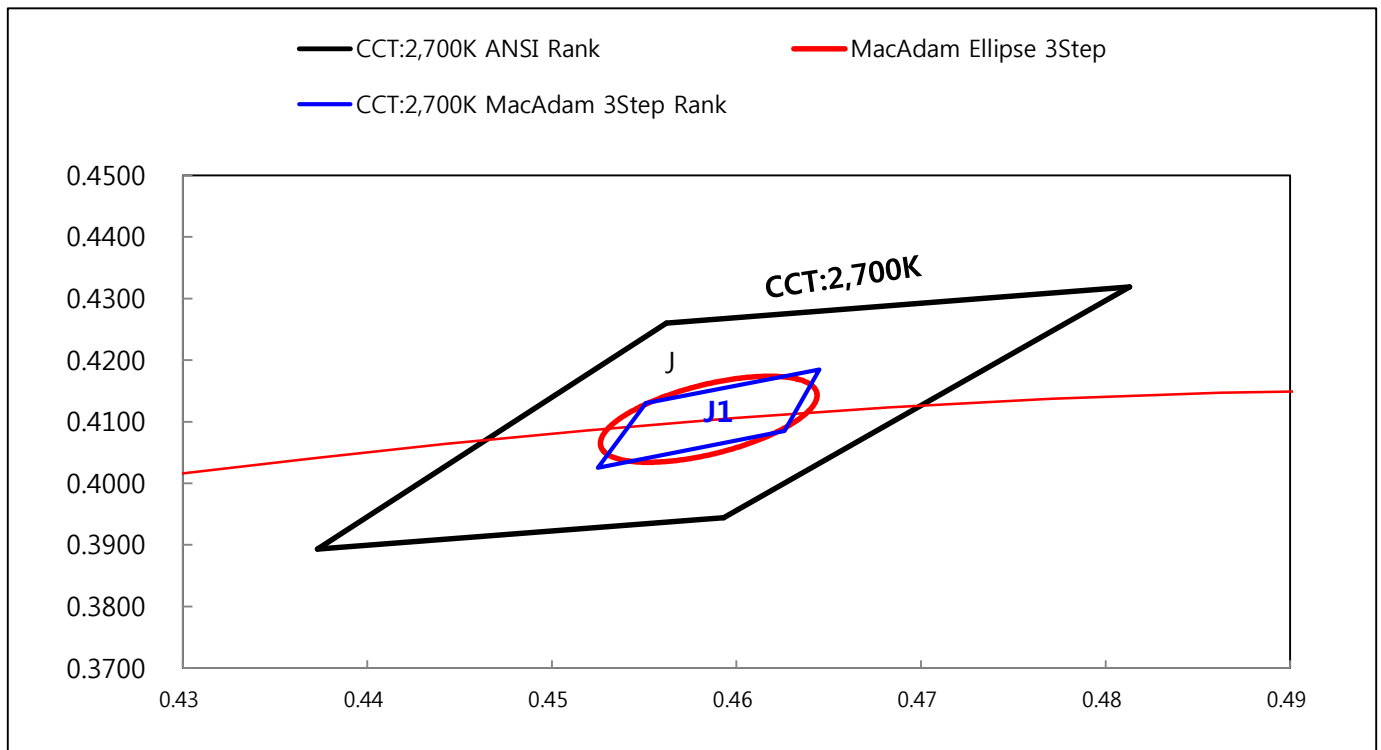

Note

* Chromaticity coordinates measurement allowance is ± 0.01



CCT(K)	CIE-x,y Avg		CCT : 2,500K		CCT : 2,500K	
	CIE-x	CIE-y	ANSI Rank		Mac-Adam 3-step Rank	
2,500K	0.4822	0.4144	CIE-x	CIE-y	CIE-x	CIE-y
	Ellipse Parameter		0.4593	0.3944	0.4783	0.4165
	Major Axis Distance a	0.0027	0.4813	0.4319	0.4770	0.4060
	Major Axis Distance b	0.0014	0.5065	0.4345	0.4863	0.4125
	Angle θ°	53.7	0.4817	0.3968	0.4876	0.4230

Note

* MacAdam 3-step range from the center of chromaticity

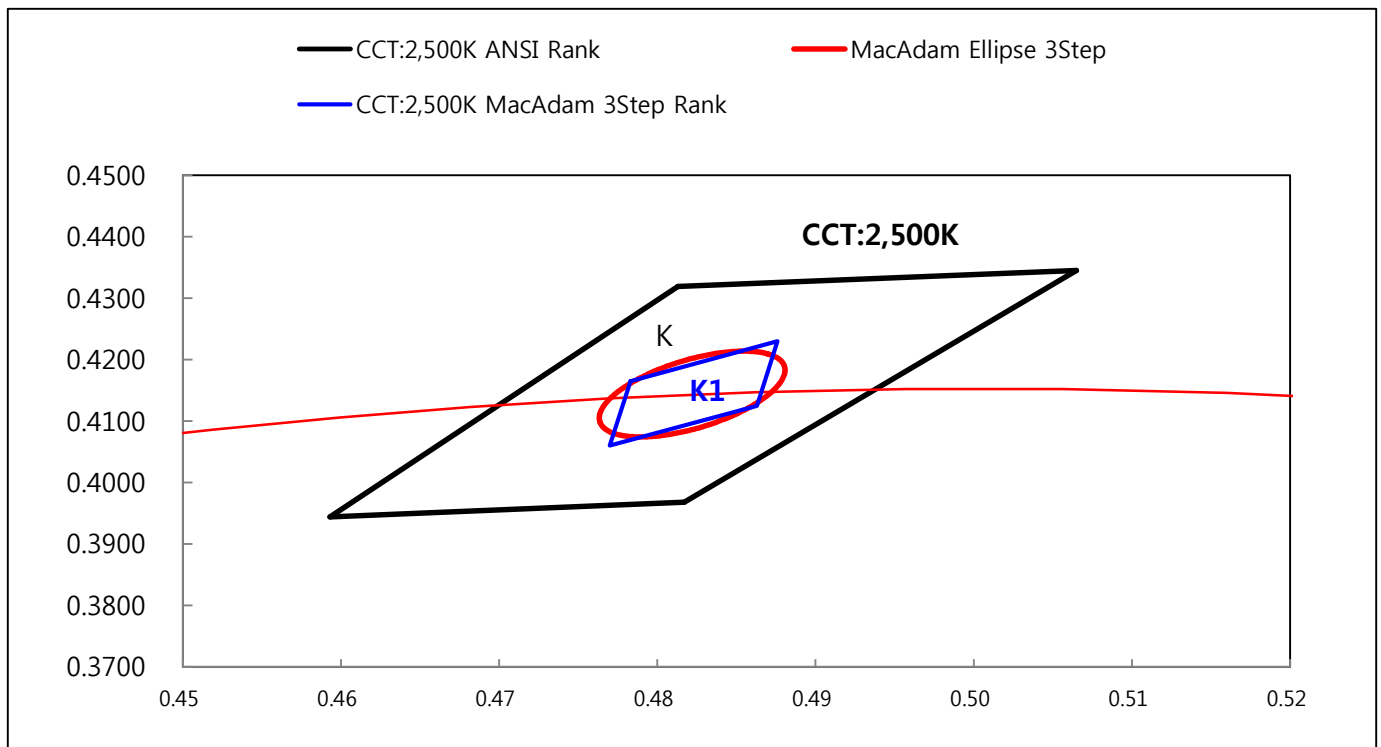

Note

* Chromaticity coordinates measurement allowance is ± 0.01

CCT(K)	CIE-x,y Avg		CCT : 2,200K		CCT : 2,200K	
	CIE-x	CIE-y	ANSI Rank		Mac-Adam 3-step Rank	
2,200K	0.5066	0.4147	CIE-x	CIE-y	CIE-x	CIE-y
	Ellipse Parameter		0.4817	0.3968	0.5023	0.4168
	Major Axis Distance a	0.0027	0.5065	0.4345	0.5010	0.4060
	Major Axis Distance b	0.0014	0.5315	0.4325	0.5110	0.4125
	Angle θ°	53.7	0.5067	0.3948	0.5123	0.4233

Note

* MacAdam 3-step range from the center of chromaticity

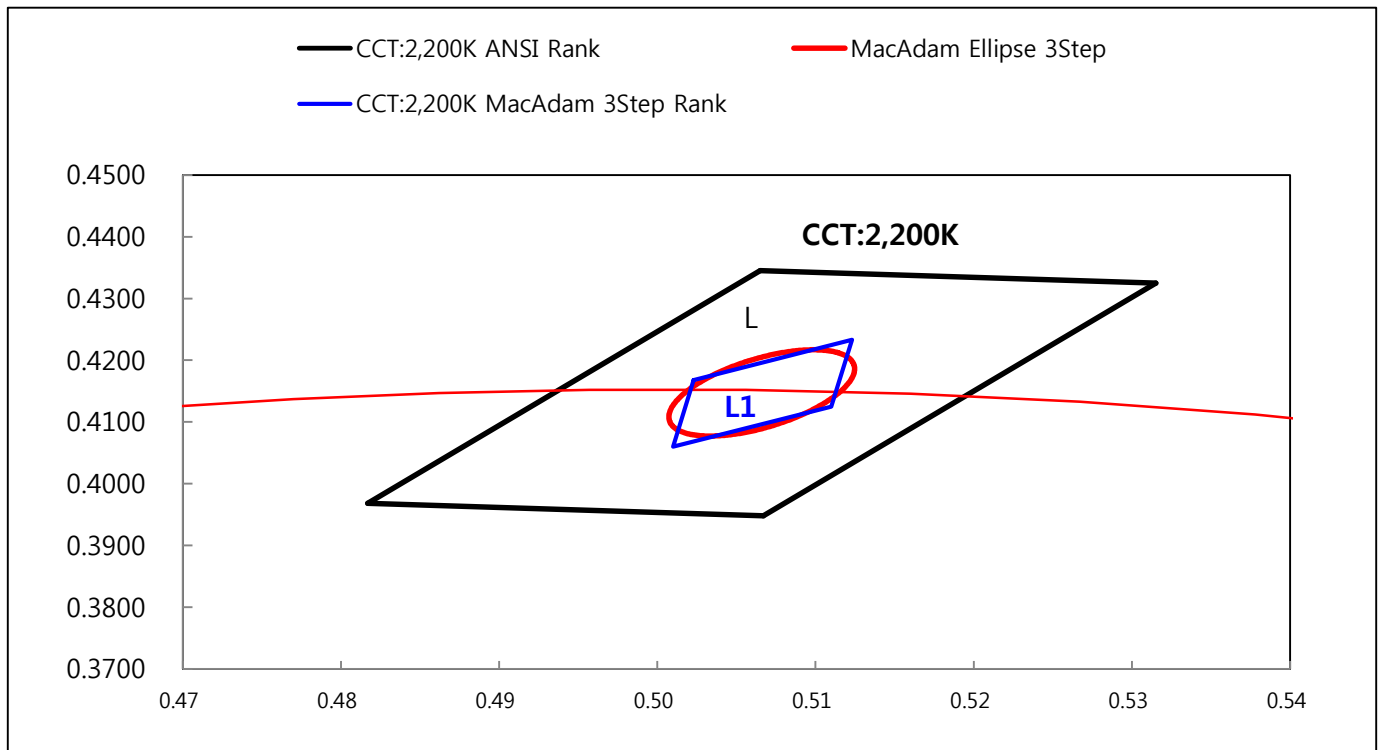

Note

* Chromaticity coordinates measurement allowance is ± 0.01

CCT(K)	CIE-x,y Avg		CCT : 2,000K		CCT : 2,000K	
	CIE-x	CIE-y	ANSI Rank		Mac-Adam 3-step Rank	
2,000K	0.5316	0.4124	CIE-x	CIE-y	CIE-x	CIE-y
	Ellipse Parameter		0.4817	0.3968	0.5023	0.4168
	Major Axis Distance a	0.0027	0.5065	0.4345	0.5010	0.4060
	Major Axis Distance b	0.0014	0.5315	0.4325	0.5110	0.4125
	Angle θ°	53.7	0.5067	0.3948	0.5123	0.4233

Note

* MacAdam 3-step range from the center of chromaticity

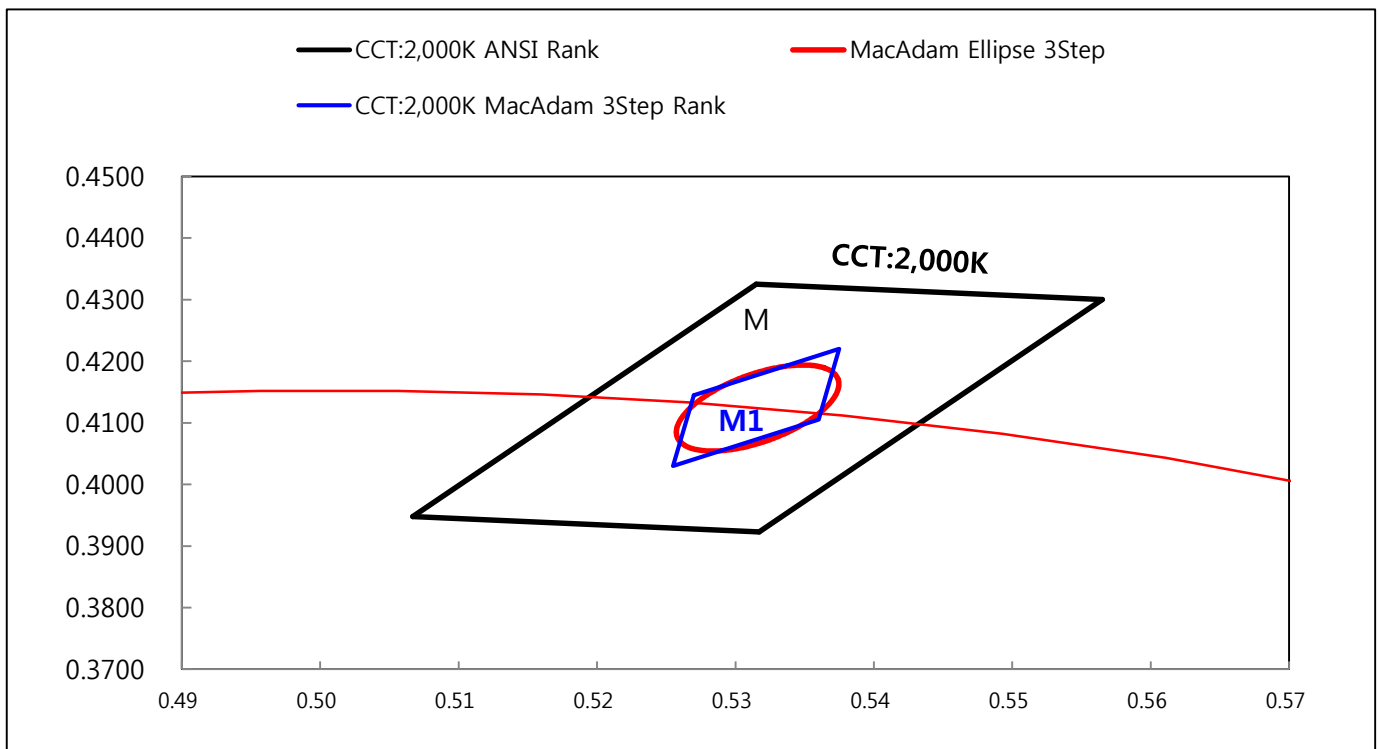

Note

* Chromaticity coordinates measurement allowance is ± 0.01

7. Results of Reliability Test

(1) Test Items and Results

Test Item	Test Condition	Notes
Temperature Cycle	-40°C~25°C~100°C~25°C (30min~5min~30min)	100 cycle
Steady State Operating Life	T _a =25°C, I _F =1,080mA	1,000 hrs
Steady State Operating Life of High Temperature	T _a =85°C, I _F =530mA	1,000 hrs
High Temperature & Humidity Storage	T _a =85°C, RH=85%	500 hrs
High Temperature Storage	T _a =100°C	1,000 hrs
Low Temperature Storage	T _a =-40°C	1,000 hrs

(2) Failure Criteria

(T_a=25°C)

Item	Symbol	Condition	Failure Criteria
Forward Voltage	V _F	I _F = 1,080mA	> U * 1.1
Total Luminous Flux	Φ _v	I _F = 1,080mA	< S * 0.85

* U : Specification Phase Limit

* S : Initial

Note

* Measurement shall be taken within 2 hours, and the test pieces should be returned to the normal ambient conditions after the completion of each test.



8. Packing standard

(1) Test Items and Results

- * 1 LED Packaging : 40 pcs/ 1 tray × 20 trays
- * 1 OUT BOX Packaging Unit : Min. 800 pcs
- * Device, quantity, lot no. shipping label will be displayed on the box.
- * Tray Dimension : 340 × 250 × 10mm
- * Material : Conductive PS

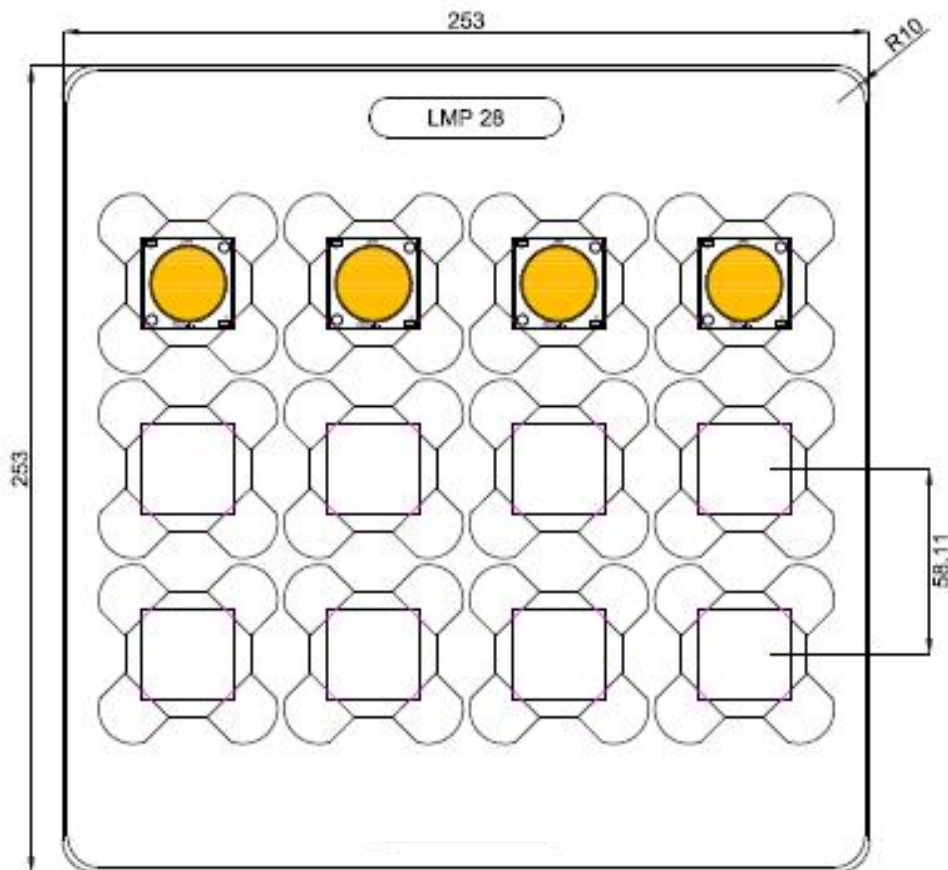

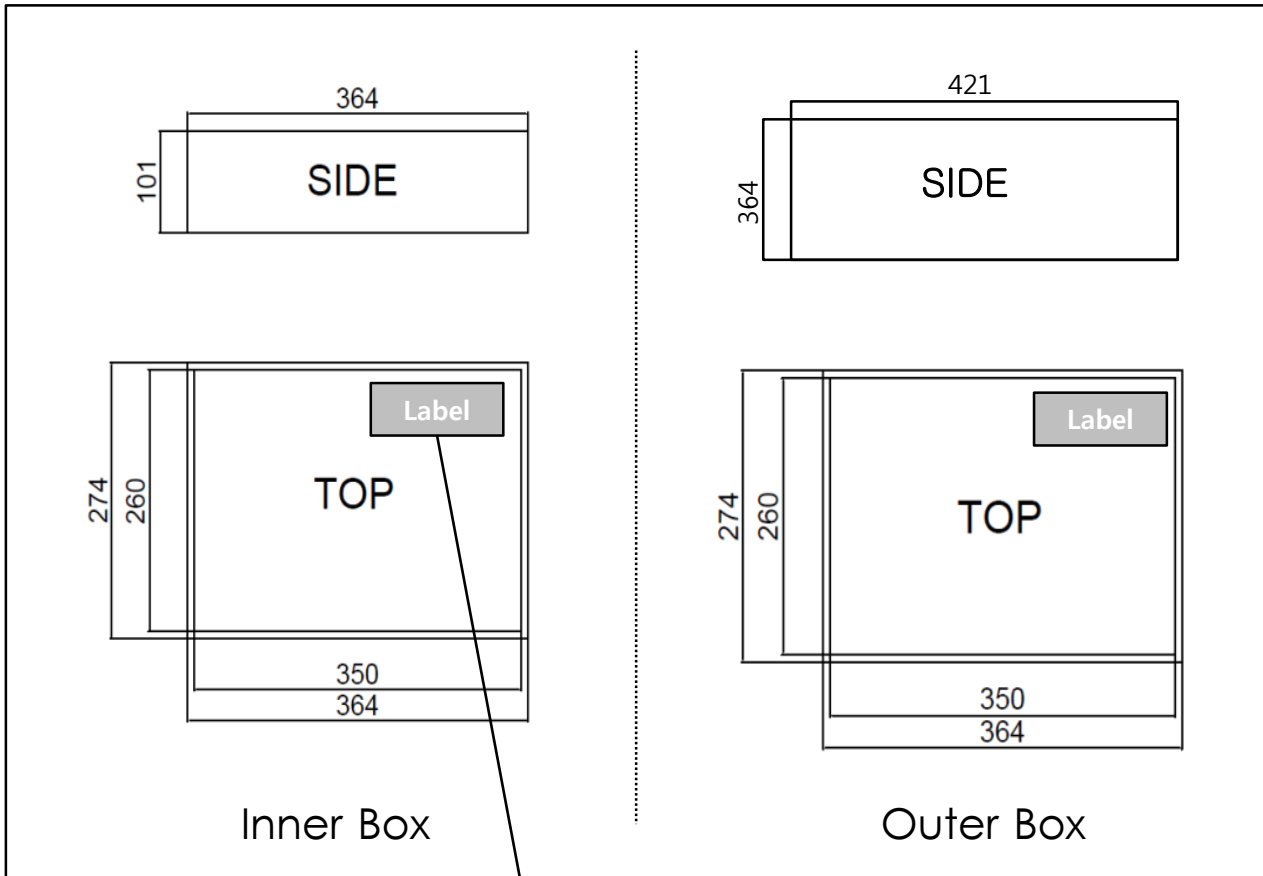

Customer

Device: AM28W-P39-A00L0

LOT No: AL150213

Q'ty: 800 pcs

ALLIX Co., Ltd.

*LOT NO.
(AL)(15)(02)(13) → (ALLIX)(Year)(Month)(Day)

9. Precautions

(1) Storage Conditions

1. Before the package is opened: The LEDs should be stored at 25°C or less and 40%RH or less after being shipped from ALLIX and the storage life limit is 6 months. If the LEDs are stored for 6 months or more, they should be stored in a sealed container with a nitrogen atmosphere and moisture absorbent material.
2. After opening the package: The LED should be stored under 40°C or less and 30%RH or less. The LEDs should be used within 168hrs(7days) after opening the package. If unused LEDs remain, it should be stored in moisture-proof packages.
3. Do not stack assemblies.

(2) Recommended Soldering Condition (This product is not adaptable to reflow process.)

- For manual soldering :

1. Please use lead-free soldering.
2. Soldering shall be implemented using a soldering bit at a temperature lower than 320~330°C, and shall be finished within 2 seconds for one land.
3. No external force shall be applied to resin part while soldering is implemented.
4. Next process of soldering should be carried out after the product is returned to ambient temperature.
5. Contacts number of soldering bit should be within twice for each terminal.

* ALLIX cannot guarantee if usage exceeds these recommended conditions. Please use it after sufficient verification is carried out on your own risk if necessary.



(3) Caution of Product Assembly

1. This product should be secured firmly by fastening an M3 screw on both sides of the product. Please be careful not to apply any stress on the product during the clamping operation. As the connection status could vary depending on materials of outer heat sink, please check thoroughly.

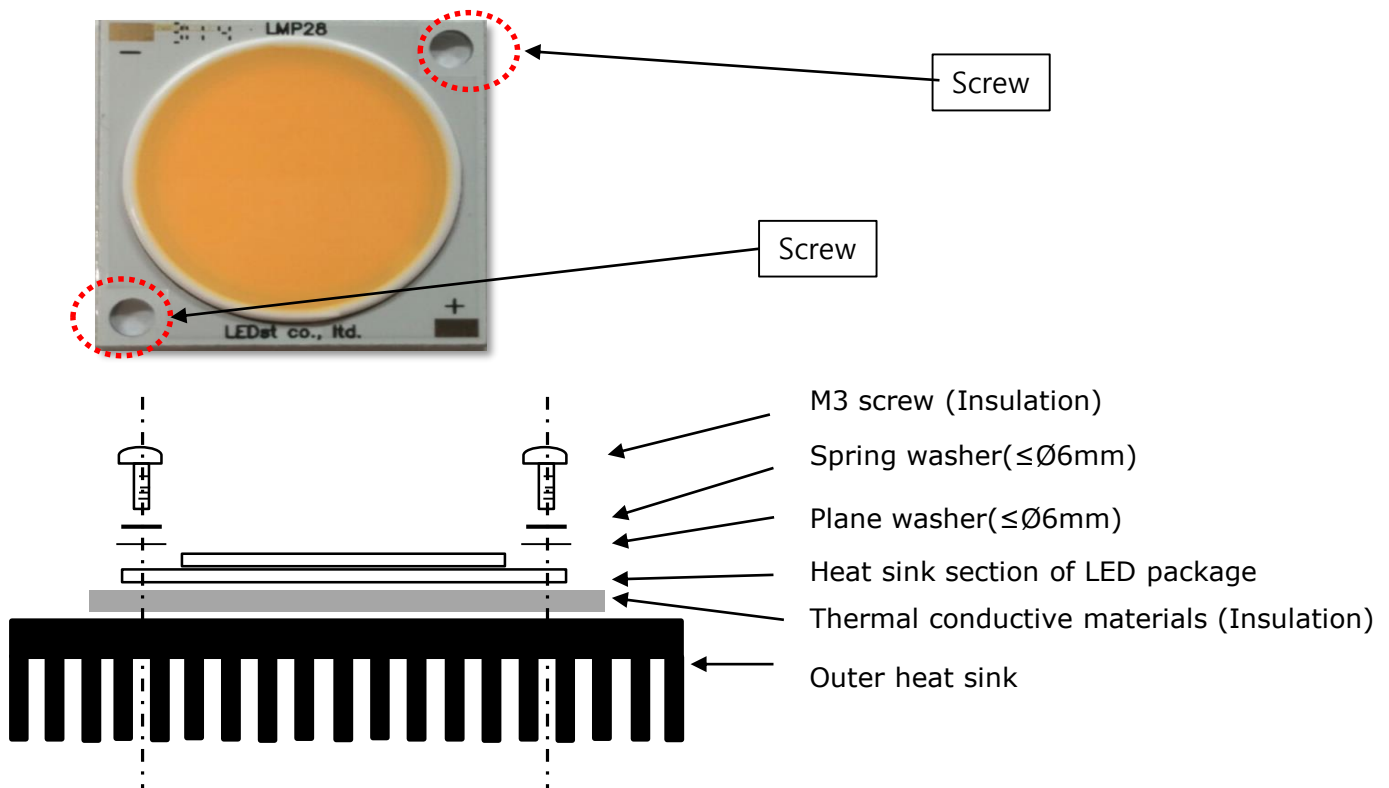

(4) Handling

1. Do not put mechanical stress on the LED.
2. Do not touch the resin with tweezers to avoid scratching or other damage.
3. In low-humidity work environment, please keep handling the LEDs with appropriate ESD grounding.
4. It is recommended to handle the LED with powder-less latex gloves.

(5) Countermeasure against static electricity

1. Handling of this product needs countermeasures against static electricity because this is a semiconductor product.
2. Please take adequate measures to prevent any static electricity from being produced such as the wearing of a wristband or anti-static gloves when handling this product.
3. Every manufacturing facility in regard to the product (plant, equipment, machine, carrier machine and conveyance unit) should be connected to ground and please avoid the product to be electric-charged.
4. After assembling the LEDs into your final product(s), it is recommended to check whether the assembled LEDs are damaged by static electricity (electrical leak phenomenon) or not.
5. It is easy to find static damaged LED dies by a light-on test with the minimum current value.

(6) Thermal Design

1. The thermal design to draw heat away from the LED junction is the most critical parameter for an LED illumination system.
2. High operating temperatures at the LED junction adversely affect the performance of LED's light output and lifetime. Therefore the LED junction temperature should not exceed the absolute maximum rating in LED illumination system.
3. The LED junction temperature while operation of LED illumination system depends upon thermal resistance of internal LED package (R_{j-c}), outer thermal resistances of LED package, power loss and ambient temperature. Please take both of the thermal design specifications and ambient temperature conditions into consideration for the setting of driving conditions.



(7) Driving Current

1. A constant current is recommended as an applying driving current to this product. In the case of constant voltage driving, please connect current-limiting resistor to each products in series and control the driving current to keep under the absolute maximum rating forward current value.
2. Electrical transient might apply excess voltage, excess current and reverse voltage to the product(s). They also affect negative impact on the product(s) therefore please make sure that no excess voltage, excess current and reverse voltage is applied to the product(s) when the LED driver is turn-on and/or turn-off.

(8) Lighting at a minimum current value

1. In a case where the minimum current is applied to the product, some of LED dice in the product might look different in their brightness due to the individual difference of the LED dice, and they are not failed.

(9) This product is not designed for usage under the following conditions.

1. If the product might be used under the following conditions, you shall evaluate its effect and appropriate them.
2. In places where the product might:
 - directly and indirectly get wet due to rain and/or at place with the fear.
 - be damage by seawater and/or at place with the fear
 - be exposed to corrosive gas (such as Cl₂, H₂S, NH₃, SO_x, Nox etc.) and/or at place with the fear.
 - be exposed to dust, fluid or oil and/or at place with the fear.

*All information included in this document such as product data, charts, diagrams, is current as of the date this document is issued. Such information, however, is subject to change without any prior notice.

